



Right Angle Helical Reducers

22mm Bores • T_{2n} 8.0Nm – 24.0Nm **1:1 - 40:1**

Crossed Helical Rotation Direction.

Using different helix direction changes direction of rotation compared to input compared to the other helix direction.

RH-Right Hand

When input rotation is clockwise, output gear is pulled towards input.

When input is counter-clockwise, output gear is pushed away from input.

LH-Left Hand

When input rotation is clockwise, output gear is pushed away from input.

When input is counter-clockwise, output is pulled towards input.

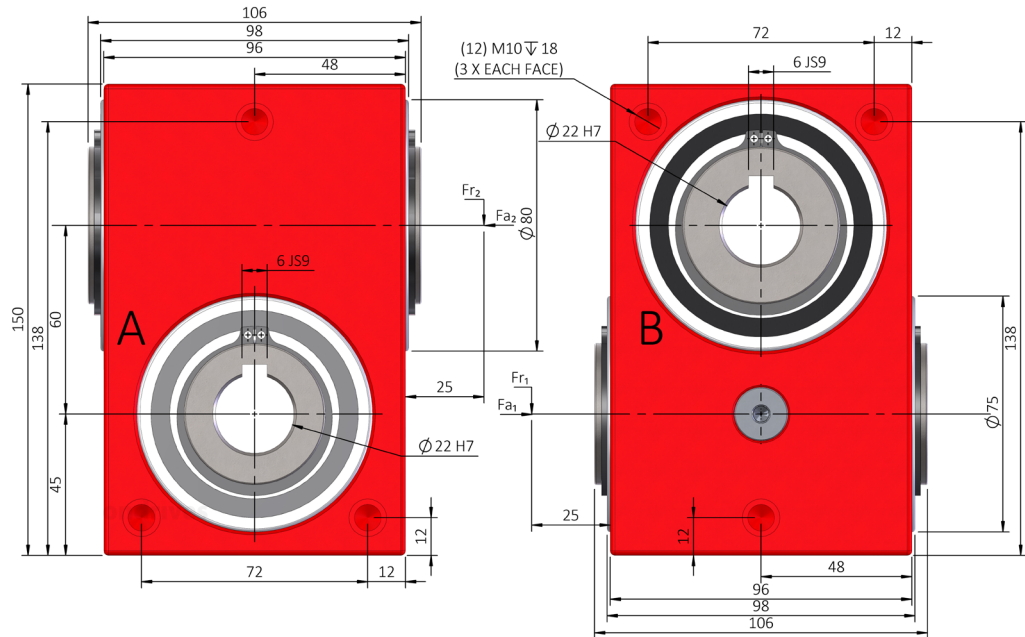

Output Backlash j	Part Numbers	Output Backlash j A	Output Backlash j AR	Gear Ratio i	Efficiency ηz	Helix Direction	Reflected Inertia at Input	Input Face
$\leq 0.75^\circ$		$\leq 0.50^\circ$	$\leq 0.166^\circ$		n1 nom		kg·m²	
E60-1-22	E60-1A-22	E60-1A-22	E60-1AR-22	1:1	94%	Right Hand	1.319×10^{-3}	B
E60-2-22	E60-2A-22	E60-2A-22	E60-2AR-22	2:1	92%	Right Hand	6.507×10^{-4}	A
E60-3-22	E60-3A-22	E60-3A-22	E60-3AR-22	3:1	91%	Right Hand	5.111×10^{-4}	A
E60-4-22	E60-4A-22	E60-4A-22	E60-4AR-22	4:1	90%	Right Hand	5.543×10^{-4}	A
E60-5-22	E60-5A-22	E60-5A-22	E60-5AR-22	5:1	80%	Right Hand	5.489×10^{-4}	A
E60-8-22	E60-8A-22	E60-8A-22	E60-8AR-22	8:1	80%	Right Hand	4.951×10^{-4}	A
E60-10-22	E60-10A-22	E60-10A-22	E60-10AR-22	10:1	73%	Right Hand	4.911×10^{-4}	A
E60-20-22	E60-20A-22	E60-20A-22	E60-20AR-22	20:1	67%	Right Hand	4.859×10^{-4}	A
E60-40-22	E60-40A-22	E60-40A-22	E60-40AR-22	40:1	60%	Right Hand	4.846×10^{-4}	A

Weight: 5.5kg.

Nom. Input Speed [S5 T_{2n}] n1 nom: 1,000 min⁻¹ (r/min)

Max. Input Speed n1 max: 1:1 to 5:1 3,000 min⁻¹ (r/min) • 8:1 to 40:1 1,000 min⁻¹ (r/min)

Lubrication: Grease Shell Gadus S2 V220AD 2

Lubrication Temperature: Max. Operating $\approx 60^\circ\text{C}$

Max. Input Radial Load F_{r1} : 800N.

Max. Input Axial Load F_{a1} : 500N.

Max. Output Radial Load F_{r2} : 800N.

Max. Output Axial Load F_{a1} : 500N.

Testing in your application is necessary.

You will need to assess duty cycles and confirm suitability with your own calculations.

Figures listed are for guidance only.

Cooling may be needed dependent on application.

E Series Crossed Axis Helical Gearbox

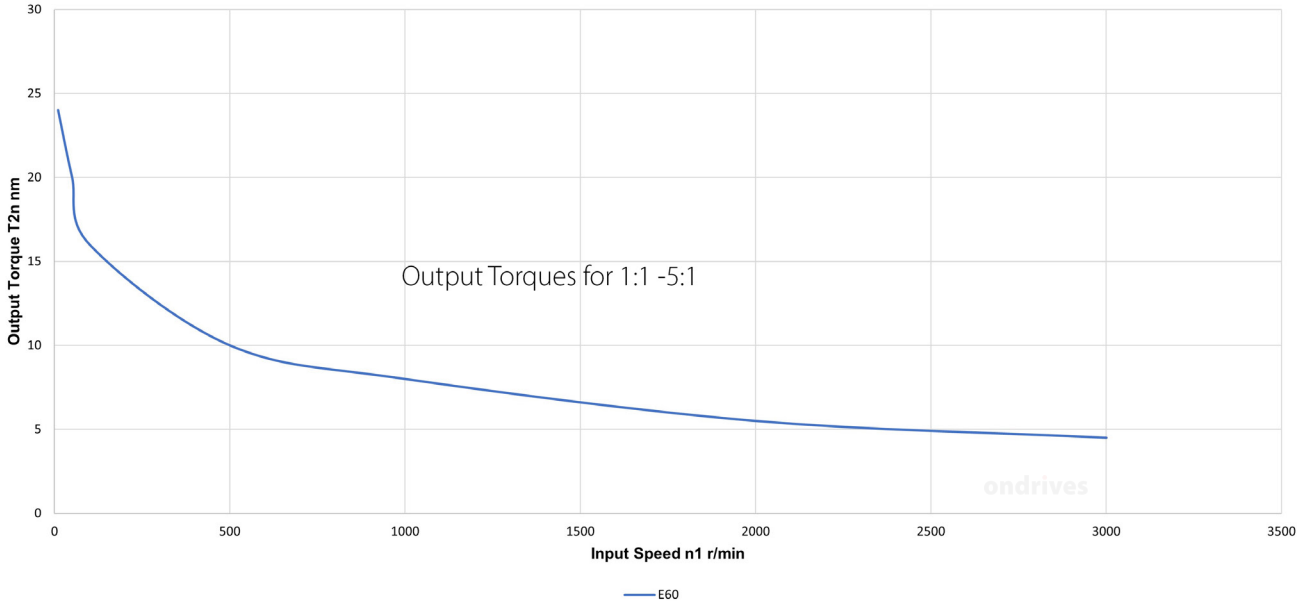

E Series Crossed Axis Helical Gearboxes

